

Vorderansicht
Maßstab: 1:30

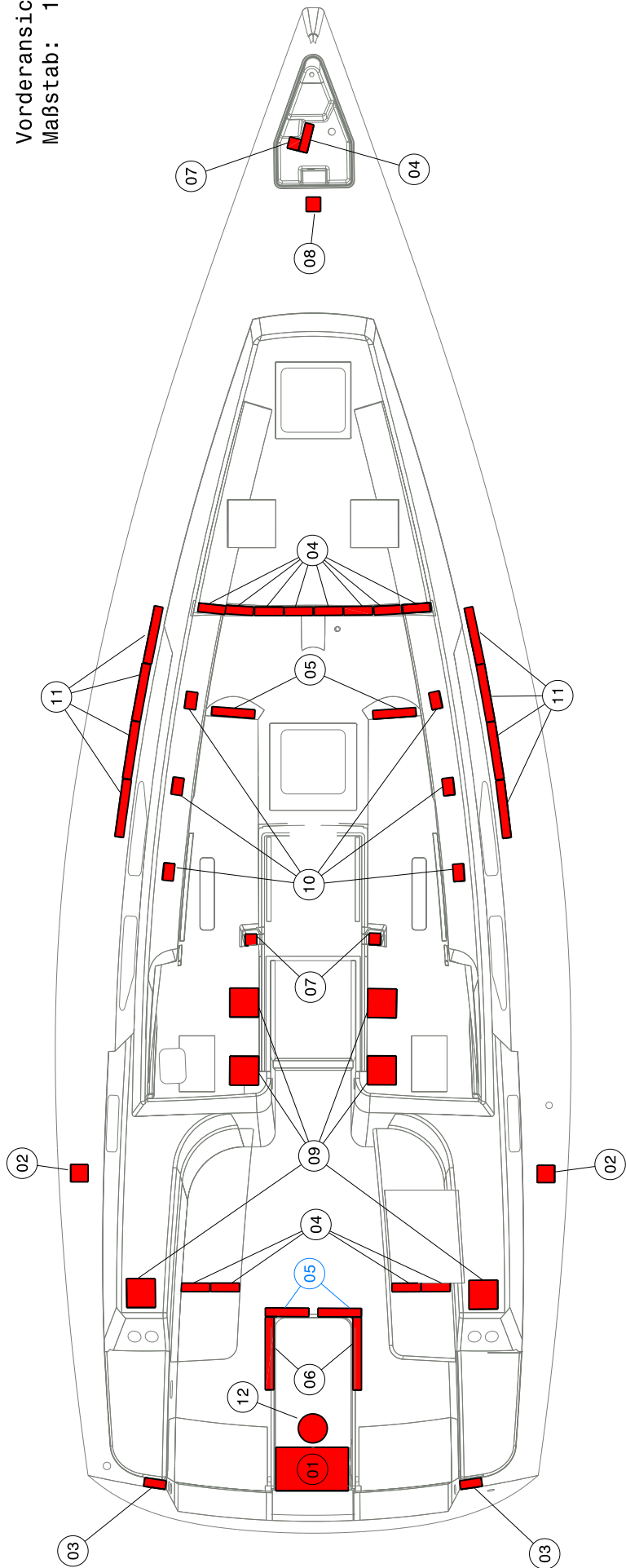

Achtung: zeigt die Innenseite des Decks!
Attention: show's the inner skin of the deck!



HANSEYACHTS AG
SALINENSTR. 22
17489 GREIFSWALD

Allgemeinbezeichnungen General tolerances		Maßstab Scale	Gewicht weight	Gültig für / valid for:
HANSEYACHTS AG SALINENSTR. 22 17489 GREIFSWALD		1:30		H855
Oberflächenbesch. Surface texture		Werkstoff material		
Name		Aluverstärkung Deck Alu reinforcement Deck		
Datum				
Bearb. 11.11.2010		Name Berger		
Freig. 18.11.2010		Bajorat		
neu Alu f. 11.11.2010		Zeichn.-Nr. H855-3040-010-02		
Steuerabdeck. 01		Drawing No. 1 / 3		
große Gemasch. 15.09.2010		gültig ab Serien-Nr.		
Kesselfarbe zu		valid off Serien-No.		
Siebstande zu				
Fockschiene				
Zust.	Änderungen	Datum	Name	

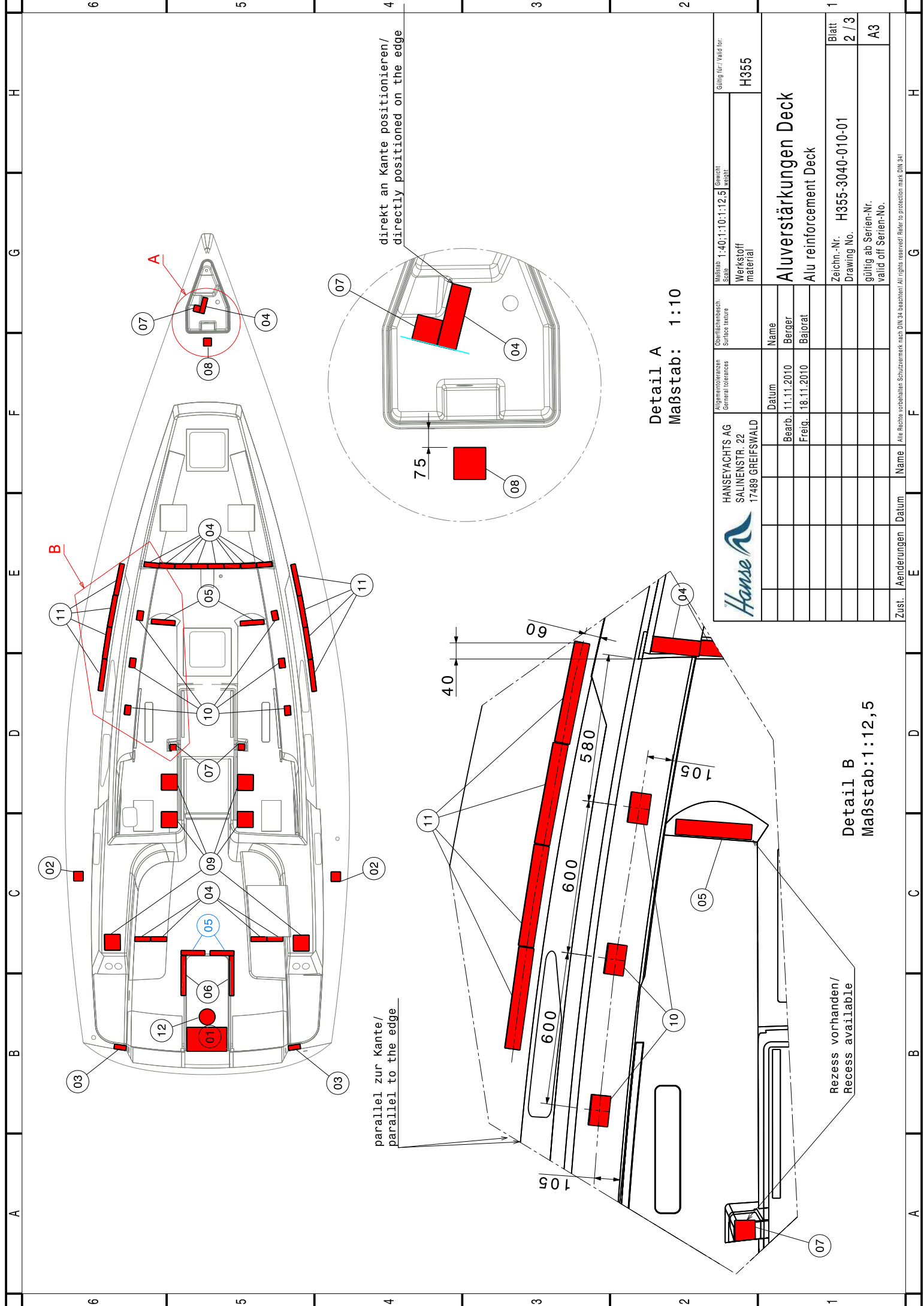

Detail A
Maßstab: 1:10

Detail B
Maßstab: 1:12,5

 HANSEYACHTS AG SALINENSTR. 22 17489 GREIFSWALD		Allgemeintoleranzen General tolerances	Oberflächentextur Surface texture	Maßstab Scale: 1:40; 1:10; 1:12,5	Gewicht Weight	Gültig für / Valid for: H855
		Werkstoff material				
		Aluverstärkung Deck Alu reinforcement Deck				
		Name Berger				
		Datum 18.11.2010				
		Bearb. 11.11.2010				
		Freig. 18.11.2010				
		Zeichn.-Nr. H855-3040-010-01 Drawing No.				
		gültig ab Serien-Nr. valid off Serien-No.				
		Blatt 2 / 3				
		A3				
Zust. Änderungen Name Datum		Alle Rechte vorbehalten! Schutzmerkmal nach DIN 24 beachten! All rights reserved! Refer to protection mark DIN 24!				

Detail D

Maßstab: 1:10

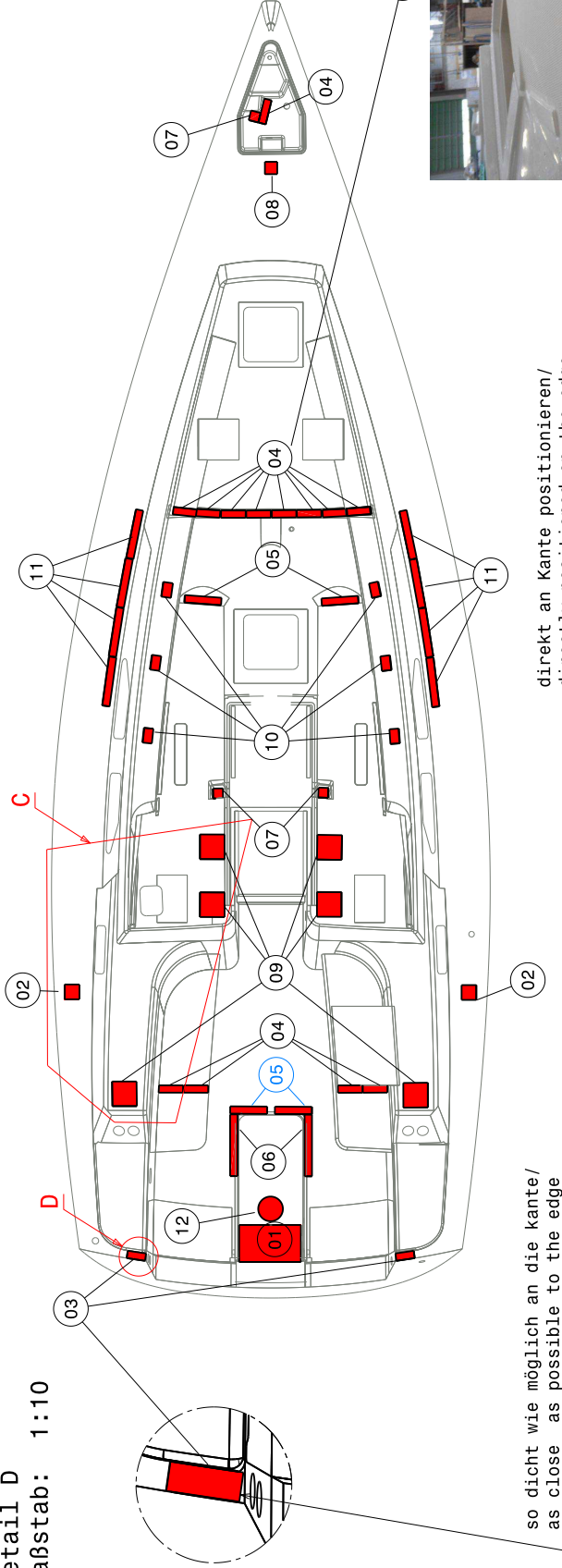

so dicht wie möglich an die kante/
as close as possible to the edge

direkt an kante positionieren/
directly positioned on the edge

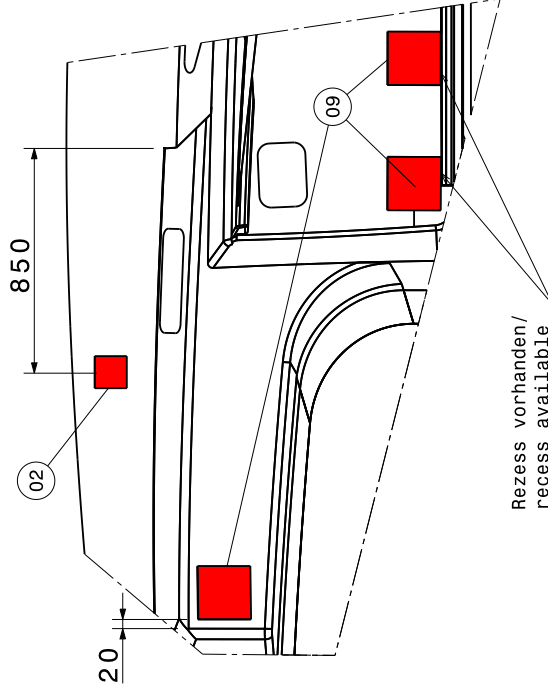

Detail C

Maßstab: 1:20

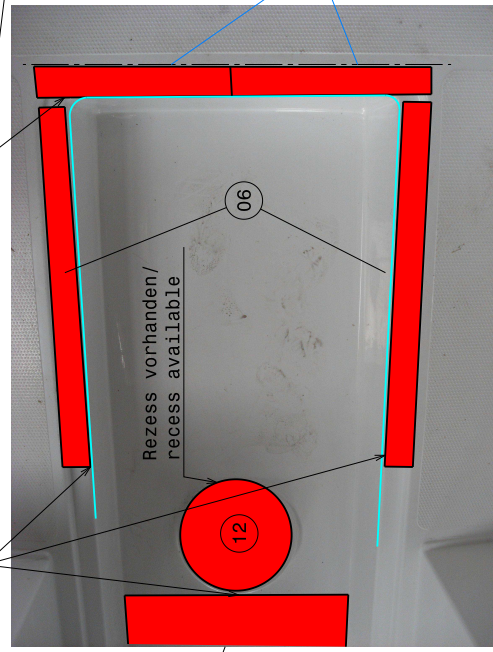
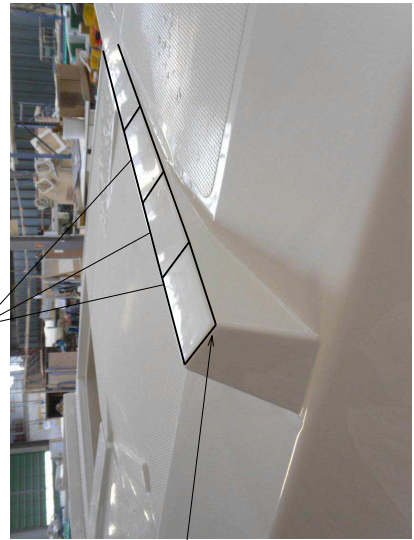

 HANSEYACHTS AG SALINENSTR. 22 17489 GREIFSWALD		Oberflächenbesch. Surface texture	Maßstab Scale: 1:20; 1:10; 1:40	Gewicht weight	Gültig für / valid for: H855
Allgemeine Toleranzen General tolerances		Werkstoff material	Aluverstärkungen Deck Alu reinforcement Deck		
Datum Date		Zeichn.-Nr. H855-3040-010-01 Drawing No.			
Bearb. 11.11.2010 Freig. 18.11.2010		gültig ab Serien-Nr. valid off Serien-No.			
Name Name		Blatt Sheet			
Datum Date		3 / 3			
Name Name		A3			
Datum Date		Zust. Änderungen			
Name Name		Alle Rechte vorbehalten! Schutzvermerk nach DIN 94 beachten! All rights reserved! Refer to protection mark DIN 94!			

